

Flat Pattern view
SCALE: 1:2

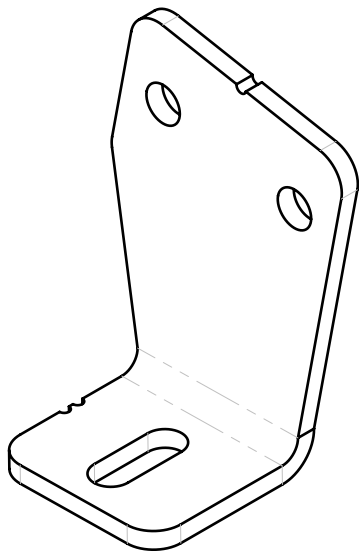
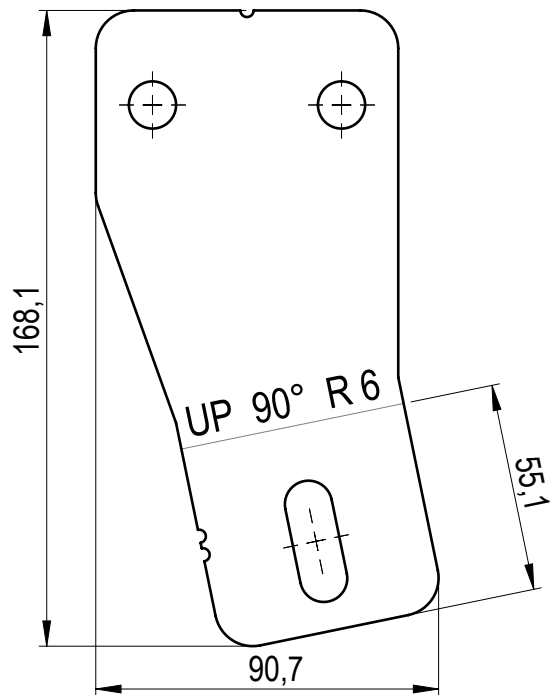
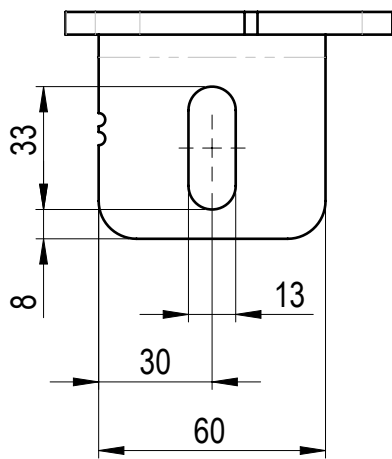

Other dimensions from DXF file

SHEET METAL INFORMATION	
Length, mm	170.1
Width, mm	82.7
Thickness, mm	6
Inside Bend Radius, mm	6
K-Factor	0.5
No. of Bends	1

	MATERIAL	S355J2	WEIGHT	0.503 Kg	DEBURR AND BREAK SHARP EDGES DO NOT SCALE DRAWING	REVISION	DATE	28.05.2025
	SURFACE PROTECTION	HDG EN ISO 1461	MACHINING	ISO 2768 mK	THERMAL CUTTING	ISO 9013 221	WELDING	ISO 13920 BF
NAME	SIGNATURE	PART NO. 105-09100-10						
Designed by	D. Dislers	DESCRIPTION					Right bracket 1M	
Drawn by	D. Dislers						SHEET 1/1	
Technical ref.								